



Fujikin Mass Flow Controller

Your Authorized West Coast Distributor
Western Valve and Fitting
4355 Technology Drive, Unit G
Livermore, CA. 94551
(O)925-443-8500
info@westernvalveandfitting.com
www.westernvalveandfitting.com

Flow Control System

FCS[®]

Thermal Series



Internet
"Beyond the Flow"
of Things



Fujikin Carp Group

We welcome customer feedback for all of our products and services

TOTAL SOLUTION COMPANY

From **FCS[®]** Supplier
To Total Solution Company
for Gas Supply Systems



Korea Service Center



Tsukuba Advanced Technology Center



China Service Center



Taiwan Service Center



America Service Center

Fujikin[®]'s
FCS[®] (Flow Control System) series
leading the way in
flow control technology.



FCS® (Flow Control System) Series

Fujikin's FCS® Series is gas flow rate control equipment for all industries. The FCS® Series includes FCS®-Pressure Series (pressure control type) and FCS®-Thermal Series (thermal flow sensor control type), two product line-ups offering two methods of control. This catalog covers the FCS®-Thermal Series, also known more generally as a Mass Flow Controller (MFC).

What is a Mass Flow Controller?

A Mass Flow Controller is a device that controls the mass flow rate. In the past, a volume flow meter was used to measure and control the flow of fluids. However, because the volume flow rate is influenced by pressure and temperature, precise measurement and control of flow is difficult to obtain with a mass flowmeter. **Fujikin's** FCS®-Thermal Series provides Mass Flow Controllers (MFC) that match a range of customer needs.

Operating Principles

When gas flows through a Mass Flow Controller (MFC), temperature changes are detected by the thermal sensor. This temperature gradient is used to compute the mass flow rate. Because each gas has a specific ability to transfer heat (i.e. heat capacity), dictated by the physical structure of the gas molecules, the MFC can proportionally control the flow rate to a given flow set point.

A range of digital control devices (RS485, DeviceNet™, EtherCAT®, PROFIBUS), as well as an analog control product (0-5VDC, 4-20mA), are part of the line-up in **Fujikin's** FCS®-Thermal Series.

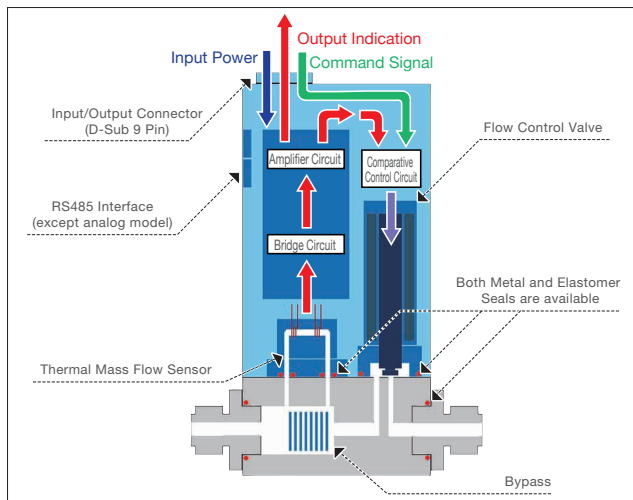

Thermal Mass Flow Sensor

As fluid runs, a temperature difference (impedance value change) occurs in the heating element between the upstream side (A) and downstream side (B) of the Thermal Mass Flow Sensor.

The difference is in the rate at which the heating element is cooled, depending on the kind of gas. The mass flow rate is measured according to the principle that the rate of cooling is related to the mass flow rate.

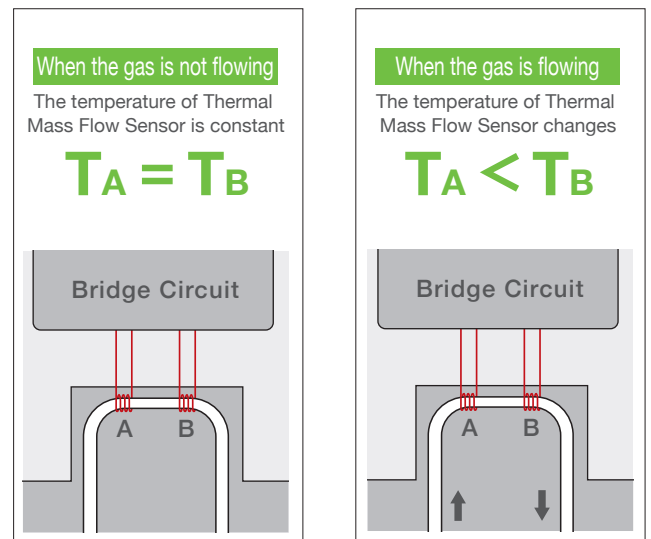



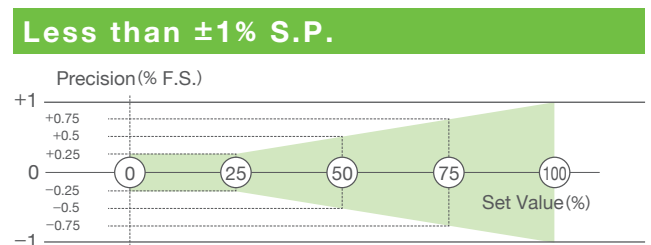
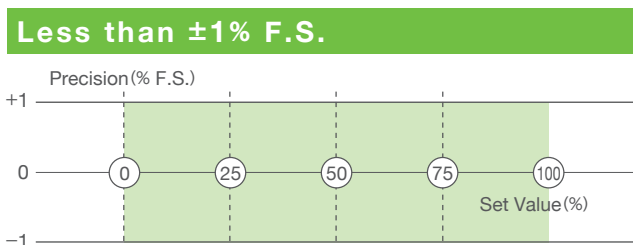

Flow Accuracy

The flow accuracy of **Fujikin's** mass flow controllers in general is ±1% F.S. (± within 1% of maximal flow). If higher accuracy is needed, **Fujikin** offers products that guarantee accuracy to within ± 1% of the set value.









Product Line-UP

Series		Mass Flow Controller					
							
Features		PI Function Model ·Equipped with Pressure Sensor ·Insensitive to sudden pressure fluctuations (Pressure Insensitive) ·With MGMR Function ·Corrosion Resistant Hastelloy Sensor ·Flow Accuracy: ±1% S.P.	MGMR Model ·MGMR(Multi Gas / Multi Range)Function ·Corrosion Resistant Hastelloy Sensor ·Flow Accuracy: ±1% S.P.	Standard Digital Model ·Flow Accuracy: ±1% F.S. ·All Flow Rate Areas: Response Time ≤ 1sec ·24V Function Model-Corresponds to EtherCAT®, PROFIBUS ·CC-Link ·Correspond to the special Specification	High Flow Rate Model ·Max. Flow Rate 500SLM ·Flow Rate Accuracy: ±1% F.S. ·Response Time: ≤ 3sec	High Temperature Model ·50 - 80°C (Please consult Fujikin for use at temperatures above 80 °C)	
Series Name		FCS-T1000MP	FCS-T1000Z	FCS-T1000F	FCS-T1200F FCS-T1500F	FCS-T1000M(Z)F-HT FCS-T1200MF-HT	
Flow Range (N ₂ Equivalent)		10SCCM - 50SLM	10SCCM - 50SLM	10SCCM - 50SLM	51 - 500SLM	10SCCM - 150SLM	
Seal Material		Metal	Metal Rubber	Metal Rubber	Metal Rubber	Metal	
Flow Accuracy		±1% S.P. (25-100%) ±0.25% F.S. (2-25%)	±1% S.P. (25-100%) ±0.25% F.S. (2-25%)	±1% F.S.	±1% F.S.(T1200) ±2% F.S.(T1500)	±1% S.P. (25-100%) (T1000MZF) ±0.25% F.S. (2-25%) (T1000MZF) ±1% F.S. (2-100%) (T1000MF, T1200MF)	
Response Time		≤1sec	≤1sec	≤1sec	≤3sec	≤1sec(10SCCM - 50SLM) ≤3sec(51 - 150SLM)	
PI Function		PI					
MGMR Function		MGMR	MGMR	MR MG ※1			
Communication	*2 Analog	±15V Drive 0-5VDC Input / Output	±15V Drive 0-5VDC	±15V Drive 0-5VDC	±15V Drive 0-5VDC	±15V Drive 0-5VDC	
		+24V Drive 0-5VDC Input / Output		+24V Drive 0-5VDC	+24V Drive 0-5VDC	+24V Drive 0-5VDC <small>For rubber type only</small>	+24V Drive 0-5VDC <small>For T1000 only</small>
		+24V Drive 4-20mA Input / Output		+24V Drive 4-20mA	+24V Drive 4-20mA	+24V Drive 4-20mA <small>For rubber type only</small>	+24V Drive 4-20mA <small>For T1000 only</small>
	*3 Digital	RS485	RS485	RS485	RS485	RS485	RS485
		DeviceNet™	DeviceNet™	DeviceNet™	DeviceNet™	DeviceNet™	DeviceNet™ <small>For T1000MF only</small>
		EtherCAT®	EtherCAT®	EtherCAT® <small>For metal type only</small>	EtherCAT®	EtherCAT®	
		PROFIBUS			PROFIBUS		
CC-Link			CC-Link				
Fittings	Union Gasket Type (UJR Type)	1/4 UJR	1/4 UJR	1/4 UJR	3/8 UJR(T1200) 1/2 UJR(T1500)	1/4 UJR(T1000M) 3/8 UJR(T1200MF)	
	Double Compression Ring Type (F900 Type)	-	1/4 F900	1/4 F900	3/8 F900(T1200) 1/2 F900(T1500)	1/4 F900(T1000M) 3/8 F900(T1200MF)	
	Integrated System Type (IGS Type)	1.5 Wseal _o 1.125 Wseal _o 1.125 Cseal	1.5 Wseal _o 1.125 Wseal _o 1.125 Cseal	1.5 Wseal _o 1.125 Wseal _o 1.125 Cseal	-	1.5 Wseal _o 1.125 Wseal _o 1.125 Cseal	
Surface Finish		Option	For metal type only	For metal type only	EP	EP Option	
Connespondence to RoHS		RoHS	RoHS	RoHS	RoHS	RoHS	
Mass Flow Meter			Mass Flow Meter	Mass Flow Meter	Mass Flow Meter	Mass Flow Meter <small>For T1000 only</small>	
Page		P.5~6	P.7~8	P.9~10	P.11	P.12	

*1: MR Specifications: Changeable to 1/3 flow of the specified full scale flow. MG Specifications: up to four kinds of gases and flow rates can be registered.

*2: Analog Interface: D-sub 9 pin. With the proviso, TM39 HRs-made HR10A-7R-6P. UPC, UPCUS has half pitch 20 P.

*3: Digital Interface: for RS485 communications, FCS-T1000 Series has RJ11 connector; FCS-T2000 Series has RJ45 connector.

	Mass Flow Controller			Mass Flow Meter	Pressure Controller		Flow Ratio Controller
							
	Quick Response/ Analog Economy Model	Analog Economy Model	High Precision Model with Piezo Actuator	Mass Flow Meter with integrated indicator	Automatic Pressure Controller	Automatic Pressure Controller	Gas Distribution Ratio Control Model
	<ul style="list-style-type: none"> ·0-5V Exclusive Use Economy Model ·Flow Rate Accuracy: ±1% F.S. ·Response Time: with 1sec. 	<ul style="list-style-type: none"> ·0-5V Exclusive Use Economy Model ·Limited to certain gases ·United type that includes a Controlled Source is also available. 	<ul style="list-style-type: none"> ·Flow Rate Accuracy: ±1% S.P. ·Low temperature thermal sensor ·Corresponds to the minute flow rate ·Corresponds to SDS ·Economy Model 	<ul style="list-style-type: none"> ·Output Indication ·Optional Needle Valve can be included ·Flow Rate Accumulation High and Low Alarm Output 	<ul style="list-style-type: none"> ·Pressure control at the upstream side or downstream side by a signal from the external pressure sensor ·Output Flow Rate 	<ul style="list-style-type: none"> ·Pressure control at the upstream side or downstream side by an internal pressure sensor ·High Temperature Specification ·with a Mass Flow meter (Option) 	<ul style="list-style-type: none"> ·Corrosion Resistant Hastelloy Sensor
	FCS-T1000L	FCS-G200	FCS-T2000	FCS-TM39	PCS-T1000F	UPC [®] UPCUS [®]	FRC-T1000MF
	10SCCM - 50SLM	10SCCM - 5SLM	5SCCM - 150SLM	10SCCM - 100SLM	10SCCM - 50SLM	—	10SCCM - 50SLM
	Metal Rubber	Rubber	Metal	Rubber	Metal Rubber	Metal	Metal
	±1% F.S. (10SCCM-30SLM) ±2% F.S. (31SLM-50SLM)	±2% F.S.	±1% S.P. (25-100%) ±0.25% F.S. (2-25%)	±2% F.S. (10SCCM-20SLM) ±3% F.S. (21-100SLM)	±1% F.S.	—	—
	≤1sec (10SCCM - 30SLM) ≤2sec (31 - 50SLM)	≤6sec (Representative value)	≤1sec (Representative value)	—	—	—	≤4sec
	±15V Drive 0-5VDC	±15V Drive 0-5VDC	±15V Drive 0-5VDC	+24V Drive 1-5VDC	±15V Drive 0-10VDC +24V Drive 0-10VDC	±15V Drive 0-5VDC	±15V Drive 0-5VDC
				+24V Drive 4-20mA			
			RS485		RS485		RS485
			DeviceNet™		DeviceNet™		DeviceNet™
	1/4 UJR	1/4 UJR	1/4 UJR (T2000) 3/8 UJR (T2150)	1/4 UJR 3/8 UJR	1/4 UJR	1/4 UJR	1/4 UJR
	1/4 F900	1/4 F900	—	1/4 F900 3/8 F900	1/4 F900	—	—
	1.5 Wseal [®] 1.125 Wseal [®] 1.125 Cseal	—	1.5 Wseal [®] 1.125 Wseal [®]	—	1.5 Wseal [®] 1.125 Wseal [®] 1.125 Cseal	1.5 Wseal [®] 1.125 Wseal [®]	—
	EP <small>For metal type only</small>				<small>For metal type only</small>		<small>For metal type only</small>
	RoHS	RoHS	RoHS	RoHS	RoHS	RoHS	RoHS
	Mass Flow Meter		Mass Flow Meter	Mass Flow Meter			
	P.13	P.14	P.15~16	P.14	P.17	P.18	P.19

Note 1: External Leak Rate: Metal Sealing: 1×10^{-11} Pa·m³/sec He, Rubber Sealing: 1×10^{-7} Pa·m³/sec He
Note 2: Please inquire regarding use under other conditions.
Note 3: DeviceNet™ is a registered trademark of the Open DeviceNet Vendor Association, Inc.

Note 4: PROFIBUS is a registered trademark of the PROFIBUS Organization.
Note 5: EtherCAT[®] is a registered trademark and patented technology, licensed by Beckhoff Automation GmbH, Germany.

PI (Pressure Insensitive) FCS-T1000MP Series



Main Function Specifications

Metal	F.S.	PI	MGMR	Analog Control	Digital Control	EP	Meter
Rubber	S.P.			±15V Drive 0-5VDC +24V Drive 0-5VDC +24V Drive 4-20mA	RS485 DeviceNet™ EtherCAT® PROFIBUS	(Option)	

Note: Not correspond to the specification of the XXX mark.

Features

- PI (Pressure Insensitive)**
 Built-in pressure sensor eliminates influence of inlet pressure fluctuations to actual flow by the original control algorithm.
- Multi Gas / Multi Range (MGMR)**
 Users may change gas and full scale flow rate easily with 8 flow rates ranging from 10 SCCM to 50 SLM.
- Hastelloy Sensor**
 Improved corrosion resistance against halogen gas.
- High Flow Rate Accuracy**
 ±1% S.P. (25 - 100%)

Specifications

Model Number	FCST1005MPF (C)	FCST1030MPF (C)	FCST1050MPF (C)
Flow Rate Range (N ₂ Equivalent)	Bin1: 10 - 30SCCM Bin2: 31 - 100SCCM Bin3: 101 - 300SCCM Bin4: 301 - 1,000SCCM Bin5: 1,001 - 3,000SCCM	Bin6: 3,001 - 10,000SCCM Bin7: 10,001 - 30,000SCCM	Bin8: 30,001 - 50,000SCCM
Seal	Metal Seal		
Valve Type	N/O: Normally Open, N/C: Normally Closed		
Controlled Volume Range	2 - 100% F.S.		
Flow Accuracy	±1% S.P. (25 - 100%), ±0.25% F.S. (2 - 25%) (Accuracy guaranteed between: 15 - 35 °C)		
Repeatability	±0.2% F.S.		
Response Time *	≤1sec		
Required Pressure Difference	50 - 300kPa (Ar: 100 - 300kPa)	N/O 100 - 300kPa (Bin6) 150 - 300kPa (Bin7) N/C 100 - 300kPa (Bin6,7) (Ar: 200 - 350kPa)	200 - 300kPa (Ar: 250 - 450kPa)
MAX. Operating Pressure	400kPaG (Ar: 500kPaG)		
Guaranteed Operating Temperature Range	5 - 50 °C		
Communication	Analog: 0 - 5VDC (Supply Power Voltage: ±15VDC) Digital: RS485, DeviceNet™, EtherCAT®		

*: Response time refers to the time to reach from minimum flow rate to ±2% F.S. of setting flow rate.

You can download the latest catalogue from URL <http://www.fujikin.co.jp/go/c75101E>

Note 1: At Fujikin, flow rates (SCCM, SLM) are converted to values at 0 °C and 101.3kPa abs. (1 atm) for calibration.

PI (Pressure Insensitive) Function Equipped

The FCS-T1005MPFC MFC is equipped with the PI Function. MFCs that aren't equipped with the PI Function can be connected in parallel and cross talk is reduced.

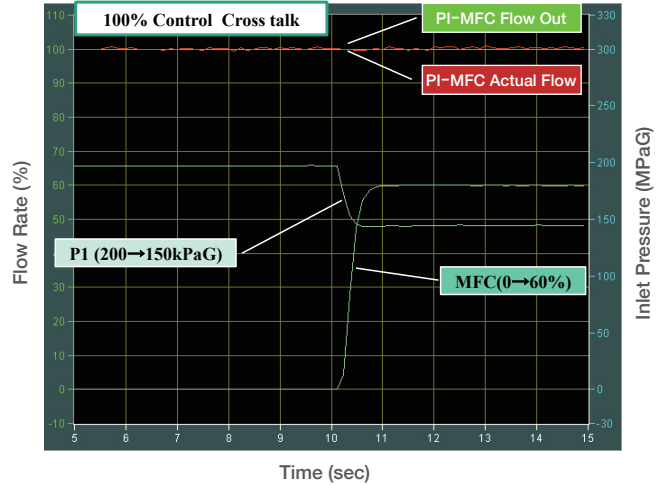
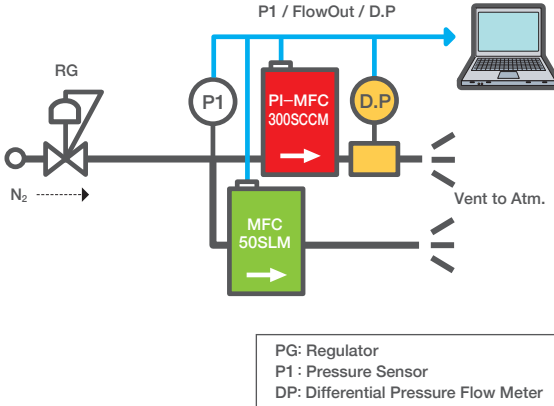

Downsizing & Cost Reduction

By omitting the pressure system equipment from the gas system, footprint size and costs are reduced.

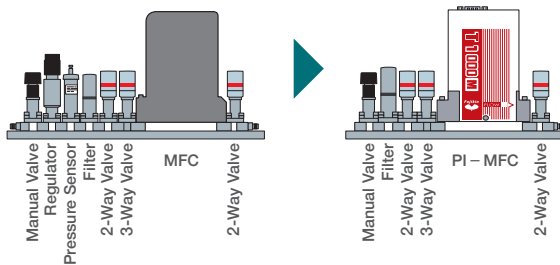

With a display

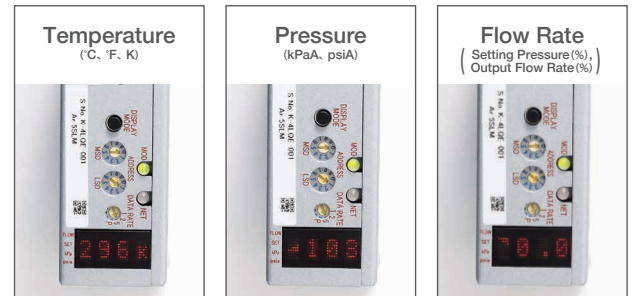

Product Code

FCST 1005 MP F C - 4J2 - F10 - N2 - R1 - U * - EP**

① FCS _o -Thermal	● FCST: Mass Flow Controller	⑦ Full Scale	● F10: 10SCCM ● F10L: 10SLM
② Flow Range	● 1005: 10 - 3,000SCCM ● 1030: 3,001 - 30,000SCCM ● 1050: 30,001 - 50,000SCCM	⑧ Gas Type	Example: N2
③ Sealing Function	● MP: Metal Seal-PI Type	⑨ MGMR	● Blank: Single Gas · Single Range
④ Communication	● F: Analog / Digital ● D: DeviceNet™ ● E: EtherCAT®	⑩ D-sub 9pin Connector Screw	● R1~R8: Multi Gas · Multi Range
⑤ Valve Mode	● Blank: Normally Open ● C: Normally Closed	⑪ User Specifications	Example: 006 25°C 1atm ● Flow Rate Unit: CCM, LM
⑥ Fittings (Face to face dimension)	● 4J2: 1/4 UJR(124mm) ● 4WS2: 1.5 Wseal _o (92mm)	⑫ Surface Finish	● Blank: Machined Finish ● EP: Electro-Polished
	● 4CW2: 1.125 Wseal _o (92mm) ● 4CL2: 1.125 Cseal(92mm)		

MGMR Model FCS-T1000Z Series



Main Function Specifications

Metal	F.S.	PI	MGMR	Analog Control	Digital Control	EP	Meter
Rubber	S.P.			+15V Drive 0-5VDC +24V Drive 0-5VDC +24V Drive 4-20mA	RS485 DeviceNet™ EtherCAT® PROFIBUS	(For metal type only)	

Note: Not correspond to the specification of the **XXX** mark.

Features

● Multi Gas / Multi Range (MGMR)

Users may change gas and full scale flow rate easily with 8 flow rates ranging from 10 SCCM to 50 SLM.

● Hastelloy Sensor

Improved corrosion resistance against halogen gas.

● High Flow Rate Accuracy

±1% S.P. (25 - 100%)

Specifications

Model Number	FCST1005 (M) ZF (C)	FCST1030 (M) ZF (C)	FCST1050 (M) ZF (C)
Flow Rate Range (N ₂ Equivalent)	Bin1: 10 - 30SCCM Bin2: 31 - 100SCCM Bin3: 101 - 300SCCM Bin4: 301 - 1,000SCCM Bin5: 1,001 - 3,000SCCM	Bin6: 3,001 - 10,000SCCM Bin7: 10,001 - 30,000SCCM	Bin8: 30,001 - 50,000SCCM
Seal	Metal Seal, Rubber Seal		
Valve Type	N/O: Normally Open, N/C: Normally Closed		
Controlled Volume Range	2 - 100% F.S.		
Flow Accuracy	±1% S.P. (25 - 100%), ±0.25% F.S. (2 - 25%) (Accuracy guaranteed between: 15 - 35 °C)		
Repeatability	±0.2% F.S.		
Response Time *	≤1sec		
Required Pressure Difference	50 - 300kPa (Ar: 100 - 300kPa)	N/O 100 - 300kPa (Bin6) 150 - 300kPa (Bin7) N/C 100 - 300kPa (Bin6, 7) (Ar: 200 - 350kPa)	200 - 300kPa (Ar: 250 - 450kPa)
MAX. Operating Pressure	400kPaG (Ar: 500kPaG)		
Guaranteed Operating Temperature Range	5 - 50 °C		
Communication	Analog: 0 - 5VDC (Supply Power Voltage: ±15VDC), 0 - 5VDC (Supply Power Voltage: +24VDC), 4 - 20mA (Supply Power Voltage: +24VDC) Digital: RS485, DeviceNet™, EtherCAT® (For Metal Seal only)		

*: Response time refers to the time to reach from minimum flow rate to ±2% F.S. of setting flow rate.

You can download the latest catalogue from URL <http://www.fujikin.co.jp/go/c75101E>

Note 1: Specifications are for MFC. Please inquire for the specifications of the Mass Flow Meter.

Note 2: At **Fujikin**, flow rates (SCCM, SLM) are converted to values at 0 °C and 101.3kPa abs. (1 atm) for calibration.

MGMR (Multi Gas / Multi Range) Functions

Users can optionally change the gas and the full scale flow rate in the flow rate range that corresponds to the specified Bin number. Choose from 8 bin numbers to match gas with flow rate range.

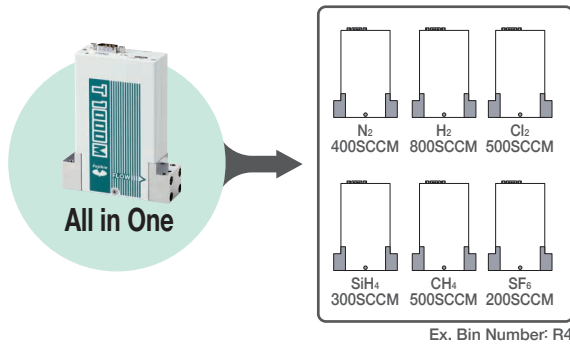

Bin Numbers

Model Number	Bin Numbers	Flow Ranges (N ₂ Equivalent)
FCST1005(M)Z	R1	10 – 30SCCM
	R2	31 – 100SCCM
	R3	101 – 300SCCM
	R4	301 – 1,000SCCM
FCST1030(M)Z	R5	1,001 – 3,000SCCM
	R6	3,001 – 10,000SCCM
FCST1050(M)Z	R7	10,001 – 30,000SCCM
	R8	30,001 – 50,000SCCM



Configuration Software

Configuration software allows for changing gas and full scale flow rate.

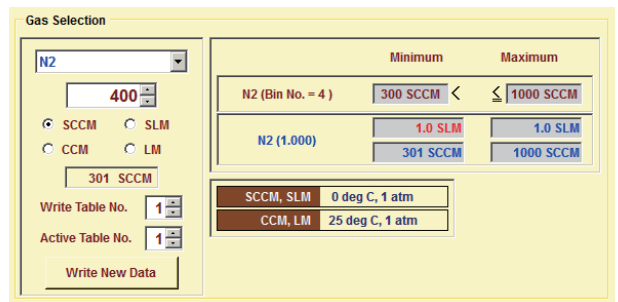
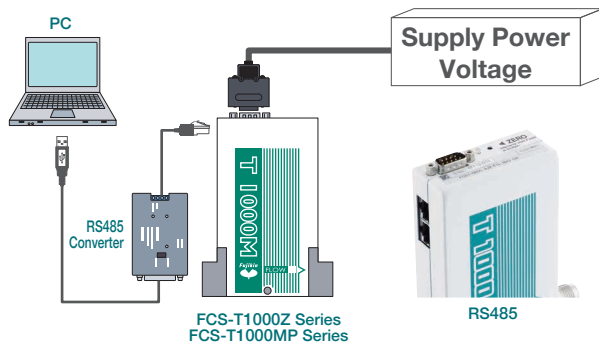

Bin Number: R4 Connection Screen

Product Code

FCST 1005 M ZF C - 4J2 - F10 - N2 - R1 - CR - U * - EP**

- ① **FCS**—Thermal ● FCST: Mass Flow Controller ● FCSTM: Mass Flow Meter
- ② **Flow Range** ● 1005: 10–3,000SCCM ● 1030: 3,001–30,000SCCM ● 1050: 30,001–50,000SCCM
- ③ **Seal Material** ● Blank: Rubber ○ M: Metal
- ④ **Communication** ● ZF: Analog / Digital ● ZD: DeviceNet™(Horizontal Connection)
● ZDT: DeviceNet™(Above Connection) ● ZE: EtherCAT®
- ⑤ **Valve Mode** ● Blank: Normally Open ● C: Normally Closed
- ⑥ **Fittings (Face to face dimension)** ● 4J2: 1/4 UJR(124mm) ○ 4J1: 1/4 UJR(106mm)
● 4F2: 1/4 F900(127mm) ○ 4CW1: 1.125 Wseal₆(79.8mm)
○ 4CW2: 1.125 Wseal₆(92mm) ○ 4WS1: 1.5 Wseal₆(79.8mm)
● 4WS2: 1.5 Wseal₆(92mm) ○ 4CL2: 1.125 Cseal(92mm)
- ⑦ **Full Scale** ● F10: 10SCCM ● F10L: 10SLM
- ⑧ **Gas Type** Example: N2
- ⑨ **MGMR** ● Blank: Single Gas · Single Range
● R1~R8: Multi Gas · Multi Range
- ⑩ **O-Ring Material** ● Blank: FKM ● CR: Chloroprene Rubber
- ⑪ **D-sub Spin Connector Screw** ● Blank: M3 ● U: inch
- ⑫ **User Specifications** Example: 006 25°C 1atm ● Flow Rate Unit: CCM, LM
- ⑬ **Surface Finish** ● Blank: Machined Finish ● EP: Electro-Polished

*: ○ corresponds only to metal seal type

Standard Digital Model FCS-T1000F Series



Main Function Specifications

Metal	F.S.	PI	MGMR	Analog Control	Digital Control	EP	Meter
Rubber	S.P.			±15V駆動 0-5VDC +24V駆動 0-5VDC +24V駆動 4-20mA	RS485 DeviceNet™ EtherCAT® PROFIBUS CC-Link	(For metal type only)	

Note: Not correspond to the specification of the **XXX** mark.

Features

- **High Speed Response**
Response time: 1 sec for any given set point
- **Flow Rate Control, Monitoring Software**
Connection to PC allows digital control up to 9 channels.
- **Corresponds to Various Communication Modes**
- **Corresponds to Special Specifications**
Example
The high-pressure specification
The low differential pressure specification
The high differential pressure specification

Specifications

Model Number	FCST1005 (M) F (C)	FCST1030 (M) F (C)	FCST1050 (M) F (C)
Flow Rate Range (N ₂ Equivalent)	10SCCM - 5SLM	6 - 30SLM	31 - 50SLM
Seal	Metal Seal, Rubber Seal		
Valve Type	N/O: Normally Open, N/C: Normally Closed		
Controlled Volume Range	2 - 100% F.S.		
Flow Accuracy	±1% F.S. (Accuracy guaranteed between: 15 - 35 °C)		
Repeatability	±0.2% F.S.		
Response Time *	≤1sec		
Required Pressure Difference	50 - 300kPa	N/O 100 - 300kPa (6 - 10SLM) 150 - 300kPa (11 - 30SLM) N/C 100 - 300kPa (6 - 30SLM)	200 - 300kPa
MAX. Operating Pressure	400kPaG		
Guaranteed Operating Temperature Range	5 - 50 °C		
Communication	Analog: 0 - 5VDC(Supply Power Voltage: ±15VDC), 0 - 5VDC(Supply Power Voltage: +24VDC), 4 - 20mA(Supply Power Voltage: +24VDC) Digital: RS485, DeviceNet™, EtherCAT®, PROFIBUS, CC-Link		

*: Response time refers to the time to reach from minimum flow rate to ±2% F.S. of setting flow rate.

You can download the latest catalogue from URL <http://www.fujikin.co.jp/go/c75101E>

Note 1: Specifications are for MFC. Please inquire for the specifications of the Mass Flow Meter.

Note 2: At **Fujikin**, flow rates (SCCM, SLM) are converted to values at 0 °C and 101.3kPa abs. (1 atm) for calibration.

High Speed Response

Response Time ≤ 1 sec for any given set point
Progressive PID Technology

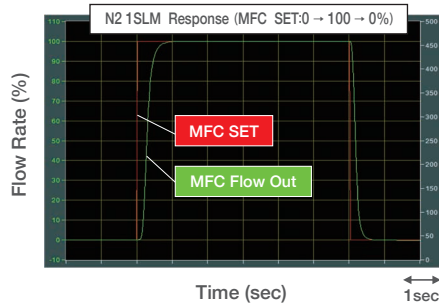

Application

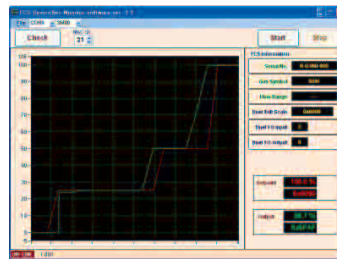

1ch Monitoring software for DeviceNet™

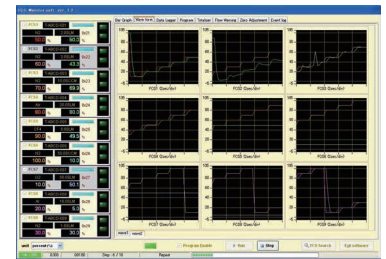

9ch Monitoring software Corrugated Chart

Corresponds to Various Communication Modes



RS485



DeviceNet™



EtherCAT®



PROFIBUS

PLC (Programmable Logic Controller)

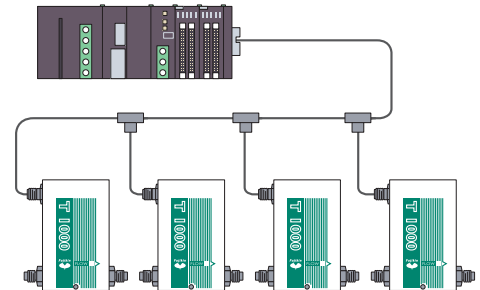

Single Gas Model, Multi Range Model, Multi Gas Model

Control System	Specifications	Contents
Digital / Analog Model	Single specification	Customer specifies gas and flow rate.
	MR(Multi Range) specification	Flow rate may be changed to even 1/3 of the specified rate.
	MG(Multi Gas) specification	It's possible to register up to 4 kinds of gas table. (Gas, flowrate)

Product Code

FCST 1005 M F C - 4J2 - F10 - N2 - CR - U * - EP**

① ② ③ ④ ⑤ ⑥ ⑦ ⑧ ⑨ ⑩ ⑪ ⑫

- ① FCS_s-Thermal ● FCST: Mass Flow Controller ● FCSTM: Mass Flow Meter
- ② Flow Range ● 1005: 10SCCM - 5SLM ● 1030: 6SLM - 30SLM ● 1050: 31SLM - 50SLM
- ③ Seal Material ● Blank: Rubber ○ M: Metal
- ④ Communication ● F: Analog / Digital ● FD: DeviceNet™(Horizontal Connection)
● FDT: DeviceNet™(Above Connection) ● E: EtherCAT® ● PB: PROFIBUS
- ⑤ Valve Mode ● Blank: Normally Open ● C: Normally Closed
- ⑥ Fittings (Face to face dimension) ● 4J2: 1/4 UJR(124mm) ○ 4J1: 1/4 UJR(106mm)
● 4F2: 1/4 F900(127mm) ○ 4CW1: 1.125 Wseal₆(79.8mm)
○ 4CW2: 1.125 Wseal₆(92mm) ○ 4WS1: 1.5 Wseal₆(79.8mm)
● 4WS2: 1.5 Wseal₆(92mm) ○ 4CL2: 1.125 Cseal(92mm)

- ⑦ Full Scale ● F10: 10SCCM ● F10L: 10SLM
- ⑧ Gas Type Example: N2
- ⑨ O-Ring Material ● Blank: FKM ● CR: Chloroprene Rubber
- ⑩ D-sub 9pin Connector Screw ● Blank: M3 ● U: inch
- ⑪ User Specifications Example: 006 25°C 1atm ● Flow Rate Unit: CCM, LM
- ⑫ Surface Finish ● Blank: Machined Finish ○ EP: Electro-Polished

*: ○ corresponds only to metal seal type.

Flow Control Equipment

Mass Flow Meter

Pressure Controller

Flow Ratio Controller

Dimensions

Accessories - Additional Related Equipments

High Flow Rate Model

FCS-T1200F, FCS-T1500F Series

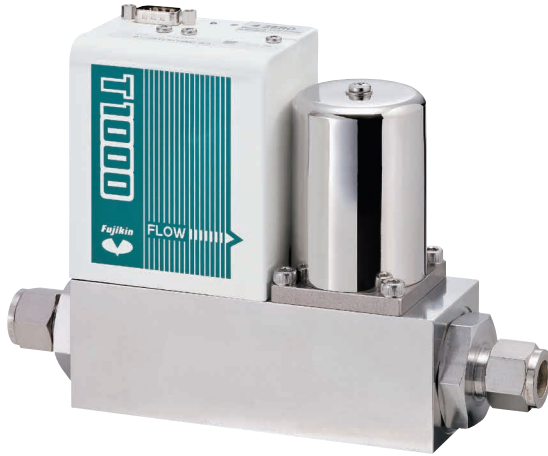

Main Function Specifications

Metal	F.S.	PI	MGMR	Analog Control	Digital Control	EP	Meter
Rubber	S.P.			+15V Drive 0-5VDC +24V Drive 0-5VDC +24V Drive 4-20mA	RS485 DeviceNet™ EtherCAT® PROFIBUS	(For metal type only)	

Note: Not correspond to the specification of the XXX mark.

Features

● High Flow Rate Model

Even a maximum flow rate of 500 SLM (converted by N₂ gas) is applicable.

● Flow Accuracy

±1% F.S. (less than F.S. 200SLM)

● Response Time

Less than 3 sec

Specifications

Model Number	FCST1200MF (C)	FCST1200F (C)	FCST1500FC
Flow Rate Range (N ₂ Equivalent)	51 - 150SLM	51 - 200SLM	201 - 500 SLM
Seal	Metal Seal	Rubber Seal	
Valve Type	N/O: Normally Open, N/C: Normally Closed		N/C: Normally Closed
Controlled Volume Range	2 - 100% F.S.		
Flow Accuracy	±1% F.S. (Accuracy guaranteed between 15 - 35 °C)		±2% F.S. (Accuracy guaranteed between: 15-35 °C)
Repeatability	±0.2% F.S.		
Response Time *	≤3sec		
Required Pressure Difference	100 - 300kPa (T1200MF 101 - 150SLM: 150 - 300kPa)		150 - 300kPa
MAX. Operating Pressure	700kPaG		
Guaranteed Operating Temperature Range	5 - 45 °C		
Communication	Analog: 0 - 5VDC (Supply Power Voltage: ±15VDC) Digital: RS485, DeviceNet™, EtherCAT®	Analog: 0-5VDC(Supply Power Voltage: ±15VDC) 4-20mA(Supply Power Voltage: +24VDC) Digital: RS485, DeviceNet™, EtherCAT®	0-5VDC(Supply Power Voltage: +24VDC)

*: Response time refers to the time to reach from minimum flow rate to ±2% F.S. of setting flow rate.

You can download the latest catalogue from URL <http://www.fujikin.co.jp/go/c75101E>

Note 1: Specifications are for MFC. Please inquire for the specifications of the Mass Flow Meter.

Note 2: At **Fujikin**, flow rates (SCCM, SLM) are converted to values at 0 °C and 101.3kPa abs. (1 atm) for calibration.

Product Code

FCST 1200M F C - 6J3 - F100L - N2 - CR - U * - EP**

① FCS - Thermal ● FCST: Mass Flow Controller ● FCSTM: Mass Flow Meter

② Flow Range-Seal ○ 1200M: 51 SLM - 150SLM-Metal Seal
● 1200: 51SLM-200SLM-Rubber Seal ● 1500: 201SLM-500SLM-Rubber Seal

③ Communication ● F: Analog / Digital ● FD: DeviceNet™(Horizontal Connection)
● FDT: DeviceNet™(Above Connection) ● E: EtherCAT®

④ Valve Mode ● Blank: Normally Open ● C: Normally Closed

⑤ Fittings (Face to face dimension) ● 6J3: 3/8 UJR(192.4mm) ● 6F3: 3/8 F900(192.5mm)
● 8J3: 1/2 UJR(199mm) ● 8F3: 1/2 F900(204.6mm)

⑥ Full Scale ● F100L: 100SLM ● F500L: 500SLM

⑦ Gas Type Example: N2

⑧ O-Ring Material ● Blank: FKM ● CR: Chloroprene Rubber

⑨ D-sub 9pin Connector Screw ● Blank: M3 ● U: inch

⑩ User Specifications Example: 006 25°C 1atm ● Flow Rate Unit: CCM, LM

⑪ Surface Finish ● Blank: Machined Finish ● EP: Electro-Polish

※: ○ corresponds only to metal seal type.

High Temperature Model

FCS-T1000M(Z)F-HT, FCS-T1200MF-HT Series



Main Function Specifications

Metal	F.S.	PI	MGMR	Analog Control	Digital Control	EP (Option)	Meter
Rubber	S.P.			+15V Drive 0-5VDC +24V Drive 0-5VDC +24V Drive 4-20mA	RS485 DeviceNet™ EtherCAT® PROFIBUS		

Note: Not correspond to the specification of the XXX mark.

Features

Corresponding to High Temperature

Guaranteed Operating Temperature Range 50 – 80 °C
(Please consult **Fujikin** for use at temperatures of 80 °C or higher.)

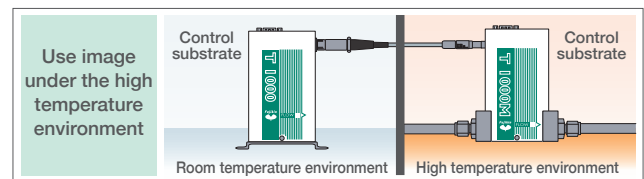

Specifications

Model Number	FCST1005MZF(C)-HT FCST1030MZF(C)-HT FCST1050MZF(C)-HT	FCST1005MF(C)-HT FCST1030MF(C)-HT FCST1050MF(C)-HT	FCST1200MF(C)-HT
Flow Rate Range (N ₂ Equivalent)	10 – 3,000SCCM 3,001 – 30,000SCCM 30,001 – 50,000SCCM	10 SCCM – 5SLM 6 – 30SLM 31 – 50SLM	51 – 150SLM
Seal	Metal Seal		
Valve Type	N/O: Normally Open, N/C: Normally Closed		
Controlled Volume Range	2 – 100% F.S.		
Flow Accuracy	±1% S.P. (25 – 100%) ±0.25% F.S. (2 – 25%)	±1% F.S.	
Repeatability	±0.2% F.S.		
Response Time *1	≤1sec		≤3sec
Required Pressure Difference *2	Digital Multi Gas Model Based on FCS-T1000MZF Series	Digital Standard Model Based on FCS-T1000MF Series	Digital High Flow Rate Model Based on FCS-T1200MF Series
MAX. Operating Pressure	400kPaG (Ar: 500kPaG)	400kPaG	700kPaG
Guaranteed Operating Temperature Range	50 – 80°C (We can calibrate the customer-specified temperature.)		
Communication	Analog: 0-5VDC(Supply Power Voltage: ±15VDC) 0-5VDC(Supply Power Voltage: +24VDC) 4-20mA(Supply Power Voltage: +24VDC) Digital: RS485, DeviceNet™ (for T1000MF only)		Analog: 0 – 5VDC (Supply Power Voltage: ±15VDC) Digital: RS485

*1: Response time refers to the time to reach from minimum flow rate to ±2% F.S. of setting flow rate.

*2: Please inquire about control of gas or liquid with low vapor pressure.

Note 1: Specifications are for MFC. Please inquire for the specifications of the Mass Flow Meter.

Note 2: At **Fujikin**, flow rates (SCCM, SLM) are converted to values at 0 °C and 101.3kPa abs. (1 atm) for calibration.

You can download the latest catalogue from URL <http://www.fujikin.co.jp/go/c75101E>

Product Code

FCST 1005 MF C - 4J2 - F10 - N2 - U * - HT - EP**

① FCS- Thermal	● FCST: Mass Flow Controller ● FCSTM: Mass Flow Meter	⑥ Full Scale	● F10: 10SCCM ● F10L: 10SLM
② Flow Range	It's based upon each model.	⑦ Gas Type	Example: N2
③ Seal Material/Communication	● MF: Metal Seal/Analog / Digital ● MZ: Metal Seal/Analog / Digital	⑧ D-sub 9pin connector screw	● Blank: M3 ● U: inch
④ Valve Mode	● MFD: Metal Seal/DeviceNet™ (Horizontal Connection)	⑨ User Specifications	Example: 006 25°C 1atm ● Flow Rate Unit: CCM, LM
⑤ Fittings (Face to face dimension)	● Blank: Normally Open ● C: Normally Closed	⑩ High Temperature Specification	● HT Guaranteed Operating Temperature Range: 50-80°C
	It's based upon each model.	⑪ Surface Finish	● Blank: Machined Finish ● EP: Electro-Polish

Flow Control Equipment

Mass Flow Meter

Pressure Controller

Flow Ratio Controller

Dimensions

Accessories- Additionally Related Equipments

Fast Response and Analog Economy Model

FCS-T1000L Series



Main Function Specifications

Metal	F.S.	PI	MGMR	Analog Control	Digital Control	EP	Meter
Rubber	S.P.			±15V Drive 0-5VDC +24V Drive 0-5VDC +24V Drive 4-20mA	RS485 DeviceNet™ EtherCAT _s PROFIBUS	(For metal type only)	

Note: Not correspond to the specification of the **XXX** mark.

Features

- **Flow Accuracy**
±1% F.S. (less than F.S. 30SLM)
- **Input/Output**
Analog (0 - 5VDC)
- **Fast Response**
Less than 1sec (less than F.S. 30SLM)

Specifications

Model Number	FCST1005 (M) L (C)	FCST1030 (M) L (C)	FCST1050 (M) L (C)
Flow Rate Range (N ₂ Equivalent)	10SCCM - 5SLM	6 - 30SLM	31 - 50SLM
Seal	Metal Seal, Rubber Seal		
Valve Type	N/O: Normally Open, N/C: Normally Closed		
Controlled Volume Range	2 - 100% F.S.		
Flow Accuracy	±1% F.S. (Guaranteed Operating Temperature Range: 15 - 35 °C)		±2% F.S. (Accuracy guaranteed between 15 - 35 °C)
Repeatability	±0.2% F.S.		
Response Time *	≤1sec		≤2sec
Required Pressure Difference	50 - 300kPa	N/O 100 - 300kPa (6 - 10SLM) 150 - 300kPa (11 - 30SLM) N/C 100 - 300kPa (6 - 30SLM)	200 - 300kPa
MAX. Operating Pressure	400kPaG		
Guaranteed Operating Temperature Range	5 - 50 °C		
Communication	Analog: 0 - 5VDC (Supply Power Voltage: ±15VDC)		

*: Response time refers to the time to reach from minimum flow rate to ±2% F.S. of setting flow rate.

You can download the latest catalogue from URL <http://www.fujikin.co.jp/go/c75101E>

Note 1: Specifications are for MFC. Please inquire for the specifications of the Mass Flow Meter.

Note 2: At **Fujikin**, flow rates (SCCM, SLM) are converted to values at 0 °C and 101.3kPa abs. (1 atm) for calibration.

Note3: Please inquire **Fujikin** separately when converting to 20 (25) °C and 101.3kPa (1 atm) for calibration.

Product Code

FCST 1005 M L C - 4J2 - F10 - N2 - CR - U * - EP**

① ② ③ ④ ⑤ ⑥ ⑦ ⑧ ⑨ ⑩ ⑪ ⑫

① FCS_®-Thermal	● FCST: Mass Flow Controller ● FCSTM: Mass Flow Meter	⑦ Full Scale	● F10: 10SCCM ● F10L: 10SLM
② Flow Range	● 1005: 10SCCM - 5SLM ● 1030: 6 - 30SLM ● 1050: 31 - 50SLM	⑧ Gas Type	Example: N2
③ Seal Material	● Blank: Rubber ○ M: Metal	⑨ O-Ring Material	● Blank: FKM ● CR: Chloroprene Rubber
④ Communication	● L: Analog	⑩ D-sub 9pin Connector Screw	● Blank: M3 ● U: inch
⑤ Valve Mode	● Blank: Normally Open ● C: Normally Closed	⑪ User Specifications	Example: 006 25C 1atm ● Flow Rate Unit: CCM ,LM
⑥ Fittings (Face to face dimension)	● 4J2: 1/4 UJR(124mm) ● 4F2: 1/4 F900(127mm)	⑫ Surface Finish	● Blank: Machined Finish ○ EP: Electro-Polish
	○ 4CW1: 1.125 Wseal _® (79.8mm) ○ 4CW2: 1.125 Wseal _® (92mm)		
	○ 4WS1: 1.5 Wseal _® (79.8mm) ● 4WS2: 1.5 Wseal _® (92mm)		
	○ 4CL2: 1.125 Cseal(92mm)		

*: ○ corresponds only to metal seal type.

Analog Economy Model FCS-G200 Series



Main Function·Specifications

Metal	F.S.	PI	MGMR	Analog Control	Digital Control	EP	Meter
Rubber	S.P.			±15V Drive 0-5VDC +24V Drive 0-5VDC +24V Drive 4-20mA	RS485 DeviceNet™ EtherCAT _s PROFIBUS		

Note: Not correspond to the specification of the **XXX** mark.

Features

- Allows flow rate measurement by analog signal and the control function.
- Supports integrated power supply source

Specifications

Model Number	FCSG205			
Practicable Gases	N ₂ , Ar, He, Air, O ₂ , SF ₆ , H ₂		Repeatability	±0.2% F.S.
Flow Rate Range (N ₂ Equivalent)	10SCCM - 5SLM		Response Time	≤6sec (Central Value)
Seal	Rubber Seal		Required Pressure Difference	50 - 300kPa (5SLM)
Valve Type	N/O: Normally Open		MAX. Operating Pressure	300kPaG
Controlled Volume Range	5 - 100% F.S. (Accuracy guaranteed between 15 - 35 °C)		Guaranteed Operating Temperature Range	5 - 50 °C
Flow Accuracy	±2% F.S.		Communication	Analog: 0 - 5VDC (Supply Power Voltage: ±15VDC)

*: Please inquire to **Fujikin** about use of the gas which isn't mentioned.

You can download the latest catalogue from URL <http://www.fujikin.co.jp/go/c75101E>

Note 1: At **Fujikin**, flow rates (SCCM, SLM) are converted to values at 0 °C and 101.3kPa abs. (1 atm) for calibration.

Mass Flow Meter with indicator FCS-TM39 Series



Main Function·Specifications

Metal	F.S.	PI	MGMR	Analog Control	Digital Control	EP	Meter
Rubber	S.P.			±15V Drive 0-5VDC +24V Drive 1-5VDC +24V Drive 4-20mA	RS485 DeviceNet™ EtherCAT _s PROFIBUS		

Note: Not correspond to the specification of the **XXX** mark.

Features

- Indicator
- Flow Rate Output
- Needle valve model is also available.
- Flow Rate Estimate and High/ Low Alarm Output

Product Code

Model Number	TM39 (V)	
Flow Rate Range (N ₂ Equivalent)	10SCCM - 20SLM	21 - 100SLM
Seal	Rubber Seal	
Flow Accuracy	±2% F.S. (Accuracy guaranteed between: 15-35 °C)	±3% F.S. (Accuracy guaranteed between: 15-35 °C)
Operating Pressure *	0.001 - 0.5MPa(G)	
Guaranteed Operating Temperature Range	0~50 °C	
Communication	Analog: 1 - 5VDC (Supply Power Voltage: +24VDC) 4 - 20mA (Supply Power Voltage: +24VDC)	
Others	Included needle valve type is available(option), corresponding to fittings Rc1/4	

*: The minimum working pressure in case of F.S. 10SCCM is the pressure at the flow of 10SCCM.

You can download the latest catalogue from URL <http://www.fujikin.co.jp/go/c75101E>

The minimum value is different depending on the full scale flow rates.

Note 1: At **Fujikin**, flow rates (SCCM, SLM) are converted to values at 0 °C and 101.3kPa abs. (1 atm) for calibration.

High Precision Model with Piezo Actuator

FCS-T2000 Series



Main Function Specifications

Metal	F.S.	PI	MGMR	Analog Control	Digital Control	EP	Meter
Rubber	S.P.			+15V Drive 0-5VDC +24V Drive 0-5VDC +24V Drive 4-20mA	RS485 DeviceNet™ EtherCAT PROFIBUS		

Note: Not correspond to the specification of the **xxx** mark.

Features

- **Piezo Actuator**
- **Low Temperature Heat System Flow Rate Sensor**
Effective with High Reaction and Low Stability Gases
- **Corresponds to the Minute Flow Rate.**
Special Model: 1, 2, 3 SCCM F.S.

Specifications

Model Number	FCST2005 (C)	FCST2020 (C)	FCST2050 (C)	FCST2150 (C)
Flow Rate Range (N ₂ Equivalent)	5SCCM - 5SLM	6 - 20SLM	21 - 50SLM	51 - 150SLM
Seal	Metal Seal			
Valve Type	N/O: Normally Open, N/C: Normally Closed		N/O: Normally Open	N/C: Normally Closed (Solenoid Actuator)
Controlled Volume Range	2 - 100% F.S.			
Flow Accuracy	±1% S.P.(25 - 100%), ±0.25% F.S. (2 - 25%)		±2% F.S.	
Repeatability	±0.2% F.S.			
Response Time	≤1sec(Typical Value)			
Required Pressure Difference	50 - 300kPa	N/O 50 - 300kPa(6 - 10SLM) 100 - 300kPa(11 - 20SLM) N/C 100 - 300kPa(6 - 10SLM) 200 - 300kPa(11 - 20SLM)	100 - 300kPa(21 - 30SLM) 150 - 300kPa(31 - 50SLM)	200 - 350kPa (51 - 100SLM) 250 - 350kPa (101 - 150SLM)
MAX. Operating Pressure	300kPaG		350kPaG	400kPaG
Guaranteed Operating Temperature Range	5 - 50 °C			
Communication	Analog: 0 - 5VDC(Supply Power Voltage: ±15VDC) Digital: RS485, DeviceNet™			Analog: 0-5VDC (Supply Power Voltage: ±15VDC)

Note 1: Specifications are for MFC. Please inquire for the specifications of the Mass Flow Meter.

You can download the latest catalogue from URL <http://www.fujikin.co.jp/go/c75101E>

Note 2: At **Fujikin**, flow rates (SCCM, SLM) are converted to values at 0 °C and 101.3kPa abs. (1 atm) for calibration.

Product Code

FCST 2005 D C - 4J2 - F10 - N2 - U - ***

① FCS₀-Thermal	● FCST: Mass Flow Controller	● FCSTM: Mass Flow Meter	⑥ Full Scale	● F10:10SCCM	● F10L:10SLM
② Flow Range	● 2005: 5SCCM - 5SLM	● 2020: 6 - 30SLM	● 2050: 31 - 50SLM	● 2150: 51 - 150SLM	
③ Communication	● Blank: Analog / Digital	● D: DeviceNet™(Horizontal Connection)	● DT: DeviceNet™(Above Connection)	⑦ Gas Type	Example: N2
④ Valve Mode	● Blank: Normally Open	● C: Normally Closed		⑧ D-sub 9pin Connector Screw	● Blank: M3
⑤ Fittings (Face to face dimension)	● 4J2: 1/4 UJR(124mm)	● 4J1: 1/4 UJR(106mm)		● U: inch	
	● 4CW1: 1.125 Wseal ₀ (79.8mm)	● 4CW2: 1.125 Wseal ₀ (92mm)		⑨ User Specifications	
	● 4WS1: 1.5 Wseal ₀ (79.8mm)	● 6J2: 3/8 UJR(163.4mm) (for 51~150SLM only)			

SDS™ (Safe Delivery Source) Model FCSDS-T2000 Series



■ Main Function Specifications

Metal	F.S.	PI	MGMR	Analog Control	Digital Control	EP	Meter
Rubber	S.P.			±15V Drive 0-5VDC +24V Drive 0-5VDC +24V Drive 4-20mA	RS485 DeviceNet™ EtherCAT _® PROFIBUS		

Note: Not correspond to the specification of the **XXX** mark.

■ Features

- Applicable Gases: AsH₃, BF₃, PH₃, SiF₄, PF₃
- Multi-gas model includes a rotary switch for changing gas

■ Specifications

Model Number	FCSDST2050		
The kind of practicable gas	AsH ₃ , BF ₃ , PH ₃ , SiF ₄ , PF ₃	Repeatability	±0.2% F.S.
Flow Rate Range (N ₂ Equivalent)	2-30SCCM	Response Time	2sec (Typical Value)
Seal	Metal Seal	Required Pressure Difference	1.33kPa (10Torr) - 133.3kPa(1000Torr)
Valve Type	N/O: Normally Open, N/C: Normally Closed	MAX. Operating Pressure	133.3kPa(1000Torr)
Controlled Volume Range	2 - 100% F.S. (Accuracy guaranteed between: 15 - 35 °C)	Guaranteed Operating Temperature Range	5 - 50 °C
Flow Accuracy	±1% F.S.	Communication	Analog: 0-5VDC(Supply Power Voltage: ±15VDC) Digital: RS485

Note 1: At **Fujikin**, flow rates (SCCM, SLM) are converted to values at 0 °C and 101.3kPa abs. (1 atm) for calibration.

You can download the latest catalogue from URL <http://www.fujikin.co.jp/go/c75101E>

Note 2: Flow rate precision guarantee: 1SCCM or over.

Note 3: Please specify the installation direction when placing an order.

Economy Model with Piezo Actuator FCS-G300 Series

■ Main Function Specifications

Metal	F.S.	PI	MGMR	Analog Control	Digital Control	EP	Meter
Rubber	S.P.			±15V Drive 0-5VDC +24V Drive 0-5VDC +24V Drive 4-20mA	RS485 DeviceNet™ EtherCAT _® PROFIBUS		

XXX Specifications are not supported

■ Features

- Flow Rate Accuracy ±1% F.S.
- Piezo Actuator

■ Specifications

Model Number	FCSG305 (C)	FCSG320 (C)	FCSG350 (C)
Flow Rate Range (N ₂ Equivalent)	10SCCM - 5SLM	6 - 20SLM	21 - 50SLM
Seal	Metal Seal		
Valve Type	N/O: Normally Open, N/C: Normally Closed		
Controlled Volume Range	2 - 100% F.S.		
Flow Accuracy	±1% F.S. (Accuracy guaranteed between: 15 - 35 °C)		
Repeatability	±0.2% F.S.		
Response Time	1sec(Central Value)		
Required Pressure Difference	50 - 300kPa	100 - 300kPa	150 - 300kPa
MAX Operating Pressure	300kPaG		
Guaranteed Operating Temperature Range	5 - 50 °C		
Communication	Analog: 0 - 5VDC(Supply Power Voltage: ±15VDC)		Digital: RS485

Note 1: At **Fujikin**, flow rates (SCCM, SLM) are converted to values at 0 °C and 101.3kPa abs. (1 atm) for calibration.

You can download the latest catalogue from URL <http://www.fujikin.co.jp/go/c75101E>

Automatic Pressure Control Controller (Outside Pressure Signal Control)

PCS-T1000F Series



Main Function Specifications

Metal	F.S.	PI	MGMR	Analog Control	Digital Control	EP	Meter
Rubber	S.P.			+15V Drive 0-10VDC +24V Drive 0-10VDC +24V Drive 4-20mA	RS485 DeviceNet™ EtherCAT® PROFIBUS	(For metal type only)	

Note: Not correspond to the specification of the **XXX** mark.

Features

- Pressure control at the upstream side or downstream side by a signal from the external pressure sensor
- Flow Rate Output
0~5VDC

Specifications

Model Number	PCST1005 (M) F (C)	PCST1030 (M) F (C)	PCST1050 (M) F (C)
Flow Rate Range (N ₂ Equivalent)	10SCCM - 5SLM	6 - 30SLM	31 - 50SLM
Seal	Metal Seal, Rubber Seal		
Valve Type	N/C: Normally Closed		
Pressure Signal Input Level	0 - 10VDC F.S.		
Pressure Control Range	2 - 100% F.S.		
Pressure Accuracy *1	±1% F.S. (Accuracy guaranteed between: 15-35 °C)		
Flow Accuracy	±1% F.S. (Accuracy guaranteed between: 15-35 °C)		
Flow Rate Output Signal	0 - 5VDC		
Response Time *2	≤3sec		
MAX. Operating Pressure	400kPaG		
Guaranteed Operating Temperature Range	5 - 50 °C		
Communication	Analog: 0 - 10VDC (Supply Power Voltage: ±15VDC) Digital: RS485		

*1: The precision of the pressure value depends on the precision of the pressure sensor.

You can download the latest catalogue from URL <http://www.fujikin.co.jp/go/c75101E>

*2: Response Time, in the case of controlling upstream pressure, is the time it takes to reach ±2% F.S. of the target pressure from the highest control pressure.

In the case of controlling downstream pressure, Response Time is the time it takes to reach ±2% F.S. of the target pressure from the lowest control pressure. The reply adjustment is sometimes necessary for the condition for the pipe capacity.
Note1: At **Fujikin**, flow rates (SCCM, SLM) are converted to values at 0 °C and 101.3kPa abs. (1 atm) for calibration.

Application Examples

For wafer adhesion in plasma devices and He gas back pressure control.

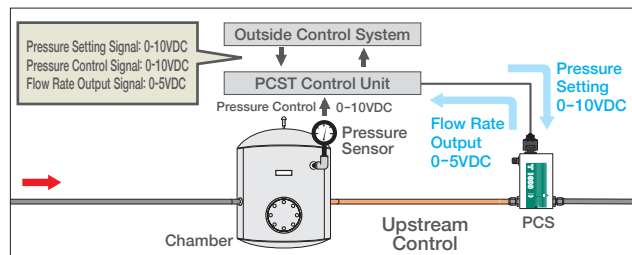
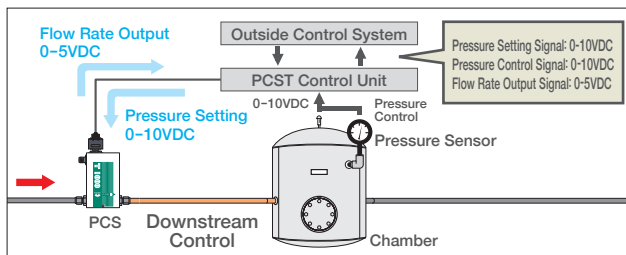

Product Code

PCST 1005 M F C - 4J2 - F10 - N2 - CR - U * - EP**

①	②	③	④	⑤	⑥	⑦	⑧	⑨	⑩	⑪	⑫
① PCS-Thermal	● PCST: Pressure Controller						⑦ Full Scale	● F10: 10SCCM	● F10L: 10SLM		
② Flow Range	● 1005: 10SCCM - 5SLM	● 1030: 6SLM - 30SLM	● 1050: 31SLM - 50SLM				⑧ Gas Type	Example: N2			
③ Seal Material	● Blank: Rubber	● M: Metal					⑨ O-Ring Material	● Blank: FKM	● CR: Chloroprene Rubber		
④ Communication	● F: Analog / Digital						⑩ D-sub 9pin Connector Screw	● Blank: M3	● U: inch		
⑤ Valve Mode	● C: Normally Closed						⑪ User Specifications	Example: 006 25C 1atm			● Flow Rate Unit: CCM, LM
⑥ Fittings (Face to face dimension)	● 4J2: 1/4 UJR (124mm)	● 4J1: 1/4 UJR (106mm)					⑫ Surface Finish	● Blank: Machined Finish	● EP: Electro-Polish		
	● 4F2: 1/4 F900 (127mm)	● 4CW1: 1.125 Wseal _o (79.8mm)									
	● 4CW2: 1.125 Wseal _o (92mm)	● 4WS1: 1.5 Wseal _o (79.8mm)									
	● 4WS2: 1.5 Wseal _o (92mm)	● 4CL2: 1.125 Cseal (92mm)									

*: ● corresponds only to metal seal type.

Automatic Pressure Control Controller (with pressure sensor)

UPC、UPCUS Series



Main Function·Specifications

Material	F.S.	PI	MGMR	Analog Control	Digital Control	EP	Meter
Rubber	S.P.			+15V Drive 0-5VDC +24V Drive 0-5VDC +24V Drive 4-20mA	RS485 DeviceNet™ EtherCAT _® PROFIBUS		

Note: Not correspond to the specification of the XXX mark.

Features

- Built-in pressure sensor controls pressure at the upstream or downstream sides.
- High temperature model applicable
150°C、250°C
- UPC_® with Mass Flow Meter (UPCM Series)

Specifications

Model Number	UPC _® (Downstream pressure controller)	UPCUS _® (Upstream pressure controller)
Pressure Range	F.S. 13.3kPa abs (100Torr)	F.S. 150/300/500 kPa abs
Control Pressure Range	1 - 100%	1 - 100% *1
Control Valve Cv Value	—	L type: 0.0055 / M Type: 0.011 / H Type: 0.03
Accuracy (after auto zero operation)	1 - 40%: ±0.2% F.S. 40 - 100%: ±0.5% S.P.	F.S.150kPa abs.[1-40%: ±0.2% F.S.、 40-100%: ±0.5% S.P.] F.S.300/500kPa abs.[1-20%: ±0.1% F.S.、 20-100%: ±0.5% S.P.]
Max. Operation Pressure	200kPaG	1MPaG
Guaranteed Operating Temperature Range	0~50°C (Accuracy guaranteed between: 15-35 °C) *2	
Pressure Setting/ Output Signal	Analog: 0.1-10VDC/0-10VDC(Supply Power Voltage: ±15VDC) Digital: DeviceNet™	Analog: 0.05 - 5VDC/0 - 5VDC(Supply Power Voltage: ±15VDC) Digital: DeviceNet™

*1: Flow control range of UPCUS changes under different conditions. Please inquire for more information.

You can download the latest catalogue from URL <http://www.fujikin.co.jp/go/c75101E>

*2: Options available for temperature specifications above 50 °C. Please inquire for more information.

Application Examples

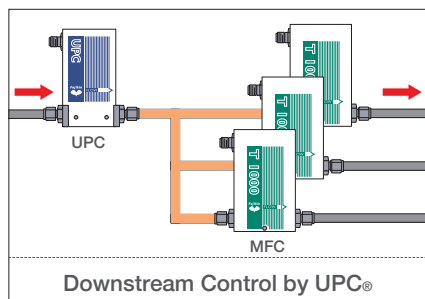

Control pressure across gas supply branched lines

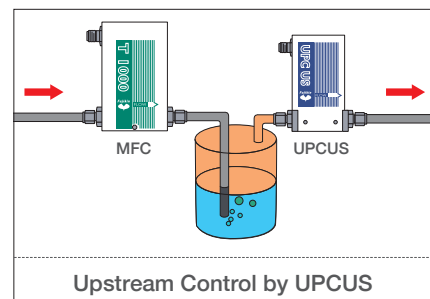

Maintain constant pressure in a liquid source tank and improve stability of the vaporized gas

Product Code

UPC D - HT50 - 4J2C - C150 - L

① ② ③ ④ ⑤ ⑥

① UPC_® Series

- UPC: Downstream control
- UPCUS: Upstream control

② Communications

- Blank: Analog
- D: DeviceNet™

③ Accuracy guaranteed Temperature Range

- Blank: 15~35°C
- HT50: 15~50°C

④ Fittings (Face to face dimension)

- 4J2C: 1/4 UJR (124mm)
- 4J1C: 1/4 UJR (106mm)

- 4WS1: 1.5 Wseal_® (79.8mm)
- 4CW2: 1.125 Wseal_® (92mm)

⑤ Full Scale Pressure Range

- C150: 150kPa abs
- C300: 300kPa abs
- C500: 500kPa abs

⑥ Control Valve Cv

- L: 0.0055
- M: 0.011
- H: 0.03

Note: Please consult Fujikin separately if you use in case of pressure range of F.S. 13.3kPa abs (100 Torr).

Gas Distribution Ratio Control Model

FRC-T1000MF Series



Main Function Specifications

Metal	F.S.	PI	MGMR	Analog Control	Digital Control	EP	Meter
Rubber	S.P.			±15V Drive 0-5VDC	RS485	(Option)	
				+24V Drive 0-5VDC	DeviceNet™		
				+24V Drive 4-20mA	EtherCAT		
					PROFIBUS		

Note: Not correspond to the specification of the **XXX** mark.

Features

- **Correct Distribution Performance**
Control the introduction of gas by the correct flow distribution ratio.
- **Hastelloy Sensor**
Improved corrosion resistance against halogen gas.
- **Splits the flow from 2 branches to 6 branches.**

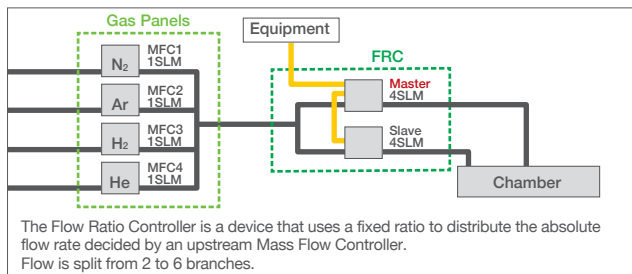

Specifications

Model Number	FRCT1005MF	FRCT1030MF	FRCT1050MF
Flow Rate Range (N ₂ Equivalent)	10 – 3,000SCCM	3,001 – 30,000SCCM	30,001 – 50,000SCCM
Seal	Metal Seal		
Valve Type	N/O: Normally Open		
Flow Rate Branching Ratio	5 – 95% (* The setting range differs depending on the number of branches and amount of gas.)		
Repeatability	±0.2% F.S.		
Response Time *	≤4sec		
Guaranteed Operating Temperature Range	10 – 40°C		
Max. Inlet Pressure	20kPaG		
Communication	Analog: 0 – 5VDC (Supply Power Voltage: ±15VDC) Digital: RS485, DeviceNet™		

*: Response time refers to the time to reach from minimum flow rate to ±2% F.S. of setting flow rate.

You can download the latest catalogue from URL <http://www.fujikin.co.jp/go/c75101E>

Note 1: At **Fujikin**, flow rates (SCCM, SLM) are converted to values at 0 °C and 101.3kPa abs. (1 atm) for calibration.

Note 2: Above specifications correspond to one FRC UNIT.

Note 3: The inlet side of FRC requires a Mass Flow Controller.

Product Code (In case of 2 branches)

FRCT 1005 M F – 4J2 – F4L/F4L – N2 – M – EP

① ② ③ ④ ⑤ ⑥ ⑦ ⑧ ⑨ ⑩

① FRC-Thermal	● FRCT: Flow Ratio Controller	⑥ Full scale flow rates Master	● F10: 10SCCM	● F4L: 4SLM
② Flow Range	● 1005: 10SCCM - 5SLM	● 1030: 6 - 30SLM	● 1050: 31 - 50SLM	⑦ Full scale flow rates Slave
③ Sealing-Function	● M: Metal			● F10: 10SCCM
④ Communication	● F: Analog / Digital	● FD: DeviceNet™		● F4L: 4SLM
⑤ Fittings (Face to face dimension)	● 4J2: 1/4 UJR (124mm)			⑧ Gas Type
				Ordering number will be N2 in spite of the kind of gas.
				⑨ UNIT
				● M: Master
				● S0*: Slave
				⑩ Surface Finish
				● Blank: Machined Finish
				● EP: Electro-Polish

Dimensions

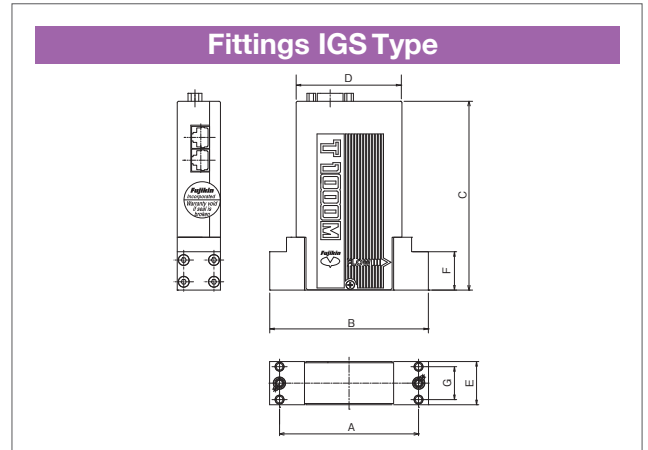
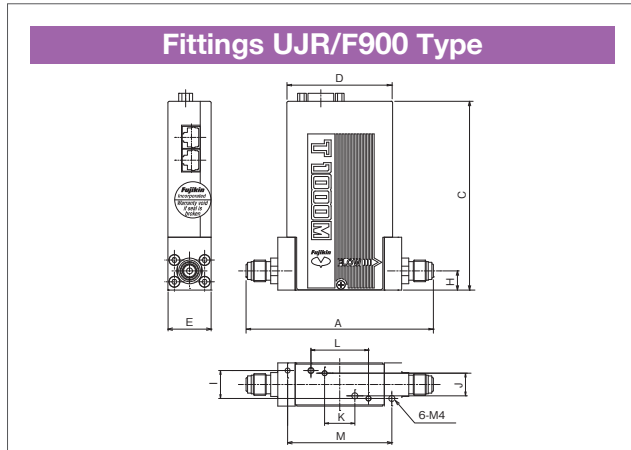

Fittings UJR/F900 Type

Model Number	A		C	D	E	H	I	J	K	L	M
	UJR	F900									
FCST1000MP	124	—	127	82.5	28.6	12.7	18.5	15	20	38.1	—
FCST1000Z/F/L	124	127	125	77	32	12.7	18.5	—	—	—	69
FCST1000MZ/MF/ML/M(Z)F-HT	124(*1)	127	125	70	28.6	12.7	18.5	15	20	38.1	69
FCST1200F	192.4	192.5	127	—	50	15	25.5	—	—	—	90
FCST1200MF	192.4	—	154	116	38	15	25.5	—	—	—	90
FCST1500F	199	204.6	140	—	50	24	25.5	—	—	—	90
FCSG200	124	127	105.2	76	25.5	12.7	18.5	—	—	—	69
FCSTM39	122.5	126.1	56.5	70	27(30.8)	12.5	10	—	—	—	56
FCST2000/G300	124(*1)	—	131	71	28.6	13/12.7	18.5	—	—	38	—
FCST2150	163.4	—	136	108	42	17	—	25.4	—	68	—
PCST1000F	124	127	125	77	32	12.7	18.5	—	—	—	69
PCST1000MF	124(*1)	127	125	70	28.6	12.7	18.5	15	20	38.1	69
UPC® /UPCUS®	124(*1)	—	128	70.5	28.1	12.7	18	—	0	—	—

*1: Please inquire about using UJR fittings (face-to-face dimension 106mm).
 Note: Please inquire regarding the dimensions of the Mass Flow Meter.

Fittings IGS Type

Model Number	A	B	C	D	E		F	G		Cap Bolt	
					1.5Wseal ^①	1.125Wseal ^②		1.5Wseal ^①	1.125Wseal ^②	1.5Wseal ^①	1.125Wseal ^②
FCST1000MP	92	105	127	82.5	39	28.6	25.4	30	21.8	①	②
FCST1000Z/F/L	92	105	127	77	39	—	37	30	—	③	—
FCST1000MZ/MF/ML/M(Z)F-HT	92(*2)	105	125	70	39	28.6	25.4	30	21.8	①	②
FCST2000	92(*2)	105	131	71	39	28.6	25.4	30	21.8	③	②
PCST1000F	92	105	127	77	39	—	37	30	—	③	—
PCST1000MF	92(*2)	105	125	70	39	28.6	25.4	30	21.8	①	②
UPC® /UPCUS®	92(*2)	105	128	70.5	—	28.5	28	—	21.8	—	④

*2: Please inquire to **Fujikin** separately when you use IGS type short face-to-face dimension connection (face-to-face dimension 79.8mm).
 Note1: Please inquire separately regarding the external dimensions of digital communication models other than RS485.
 Note2: Flow Rate Control System and Pressure Control System are fixed with 4 Cap Bolts. ①CB-M5×30 ②CB-M4×29 ③CB-M5×40 ④CB-M4×10

Mass Flow Controller Signal Connector

Pin Numbers	Signal	Description
1	Valve Opening and shutting Input	+15VDC: Full Open, -15VDC: Shut
2	Flow Rate Setting Voltage 0~5VDC	Flow Rate Output Voltage plus Side 0~5VDC
3	Electric Source: +15VDC	Power Supply Feed Line: 50mAF
4	Electric Source: 0VDC	± 15VDC Common Line
5	Electric Source: -15VDC	Negative Power Supply Feed Line: 200mA
6	Flow Rate Setting Voltage 0.1~5VDC	*Flow Rate Setting Input Plus Side 0.1~5VDC
7	Flow Rate Output Voltage COMMON	Common Line of Flow Rate Output Voltage
8	Flow Rate Setting Voltage COMMON	Common Line of Flow Rate Setting Voltage
9	N.C.	Unused Pin (Please don't connect.)

*1: Signal Connector of FCS-T1000 Series
 *2: Pin7 and Pin8 are connected inside FCS.
 *3: Pin9 can be designated "Valve Test PT" by special specification.
 *4: Please inquire **Fujikin** separately about connector specifications of digital communication.

Pin Numbers	Signal	Description
1	N.C.	Unused Pin (Please don't connect.)
2	N.C.	Unused Pin (Please don't connect.)
3	Signal[-Txd/Rxd]	RS-485 2 Line System Send and Receive Minus
4	Signal[+Txd/Rxd]	RS-485 2 Line System Send and Receive Plus
5	N.C.	Unused Pin (Please don't connect.)
6	N.C.	Unused Pin (Please don't connect.)

Pin Numbers	Signal	Description
1	Signal COM	RS-485 Signal Common
2	Signal COM	RS-485 Signal Common
3	N.C.	Unused Pin (Please don't connect.)
4	Signal[-Txd/Rxd]	RS-485 2 Line System Send and Receive Minus
5	Signal[+Txd/Rxd]	RS-485 2 Line System Send and Receive Plus
6	N.C.	Unused Pin (Please don't connect.)
7	N.C.	Unused Pin (Please don't connect.)
8	N.C.	Unused Pin (Please don't connect.)

Flow Control Equipment

Mass Flow Meter

Pressure Controller

Flow Ratio Controller

Dimensions

Accessories - Additional/Related Equipments

FCS®-Thermal Series Accessories



Power Supply for 6 Units

Part Number: FCS-T1000-PS 3/6/9



Digital Panelmeter

Part Number: FCS-DPM-05-L100



Control Potentiometer

Part Number: FCS-SET-02-L100



Power Supply Meter

Part Number: FCS-PM1000A-SP



Connector Change Cable

Wide range of connectors supported

Note: Specifications are subject to change without prior notice.

Connection Examples

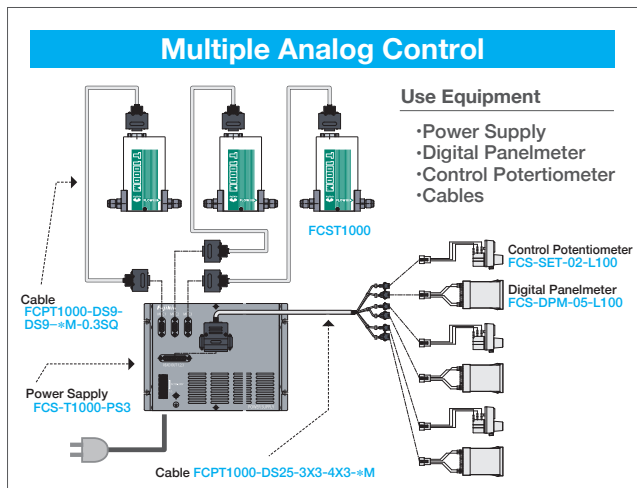
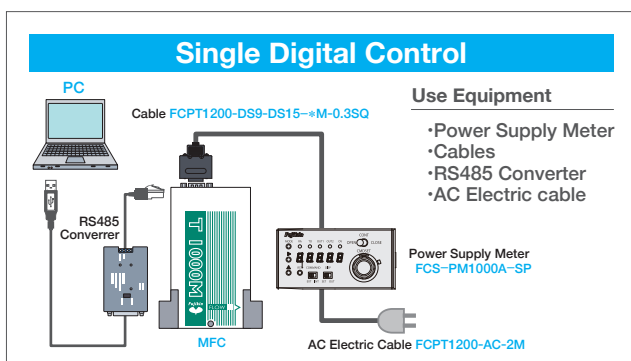
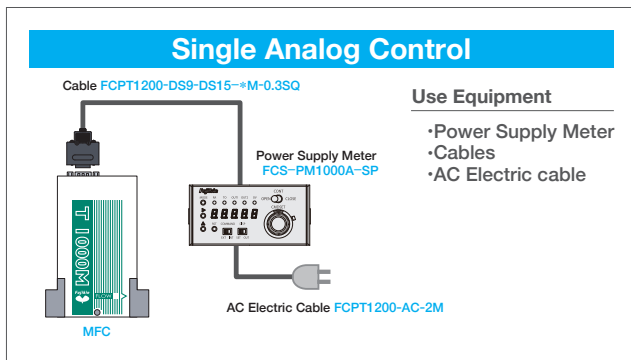

Control Source Integrated-type Unit Flow Module®



Flow Control Equipment

Mass Flow Meter

Pressure Controller

Flow Ratio Controller

Dimensions

Accessories-Additional Related Equipments

Additionally Related Equipments

Flow Control Systems (FCS®-Pressure Series)



FCS-P7000 Series

2007 Encouragement Award



FCS® Body Corresponding to hotness (250 °C)

2010 Machinery Component Award



FALVS® (Fujikin Advance Liquid Vaporize System)
(Advanced Liquid Vaporize System)

2015 Cho Monodzukuri [super manufacturing] Encouragement Award

Flow Control Equipment

Mass Flow Meter

Pressure Controller

Flow Ratio Controller

Dimensions

Accessories Additionally Related Equipments

Integrated Gas System IGS



IGS

2005 Encouragement Award

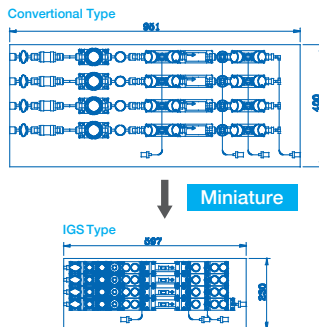

One third the size of conventional gas panels.

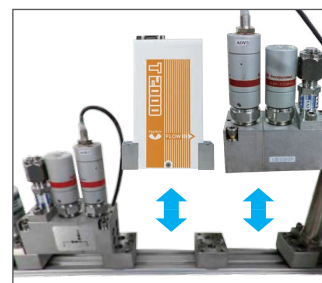

Upper Part of Composition Parts Perfect Attachment and Removal System

All upper part assemblies can be attached or removed in upper one-way.

Stop Valves



NEW MEGA® Series

Metal Diaphragm



Ball Valves Seies

Filters



FUFL Sires

Wetted parts are perfectly oil-free. 0.1, 0.5, 2, 5, 10 μm are applicable as element sizes.



Your Authorized West Coast Distributor
Western Valve and Fitting
4355 Technology Drive, Unit G
Livermore, CA. 94551
(O)925-443-8500
info@westernvalveandfitting.com
www.westernvalveandfitting.com

Fujikin® Carp® Group



The Year 2005
The 1st Monozukuri (manufacturing)
Nippon Grand Awards
: Excellence Prize